

**RAILWAY**

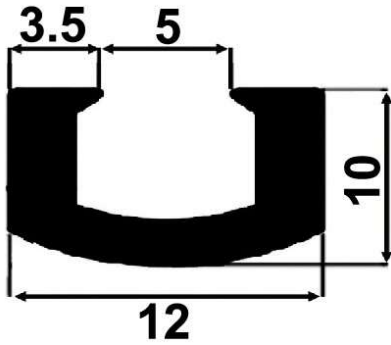

SL.NO.	SECTION NO.	WEIGHT(KG/M)
1	5200	0.172

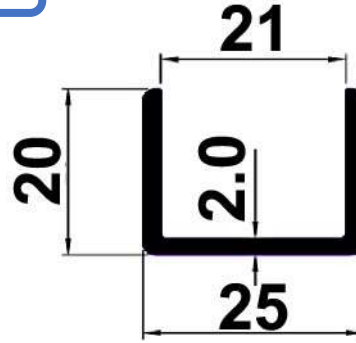

SL.NO.	SECTION NO.	WEIGHT(KG/M)
1	5201	0.332

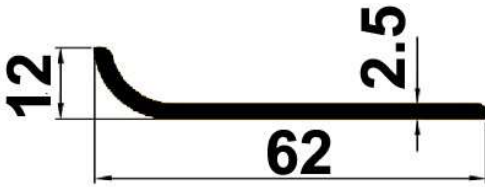

SL.NO.	SECTION NO.	WEIGHT(KG/M)
1	5202	0.474

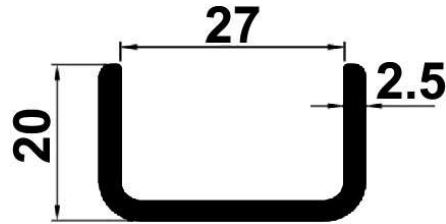

SL.NO.	SECTION NO.	WEIGHT(KG/M)
1	5203	0.428

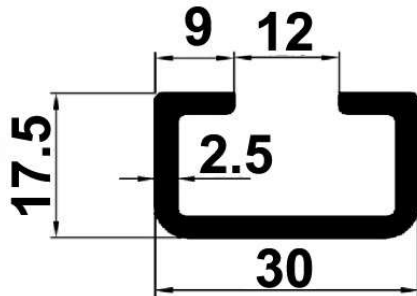

SL.NO.	SECTION NO.	WEIGHT(KG/M)
1	5204	0.474

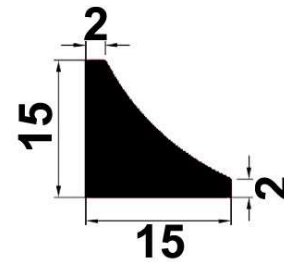

SL.NO.	SECTION NO.	WEIGHT(KG/M)
1	5205	0.325

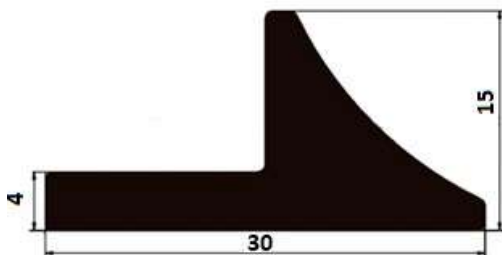

SL.NO.	SECTION NO.	WEIGHT(KG/M)
1	5206	0.487

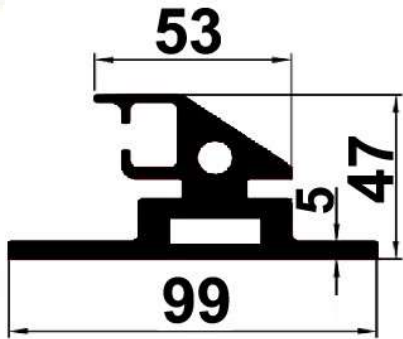

SL.NO.	SECTION NO.	WEIGHT(KG/M)
1	5207	3.641

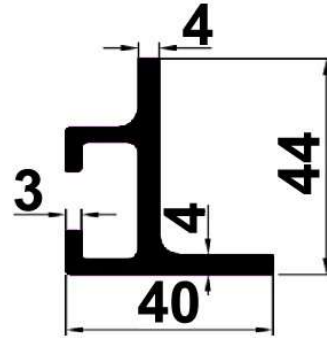

SL.NO.	SECTION NO.	WEIGHT(KG/M)
1	5208	1.057

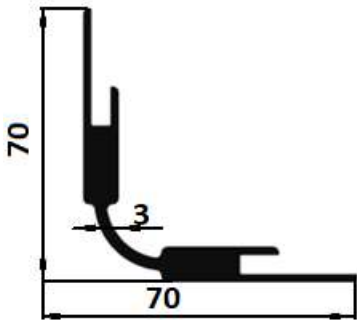

SL.NO.	SECTION NO.	WEIGHT(KG/M)
1	5209	1.595

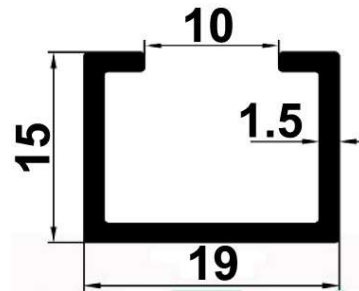

SL.NO.	SECTION NO.	WEIGHT(KG/M)
1	5210	0.210

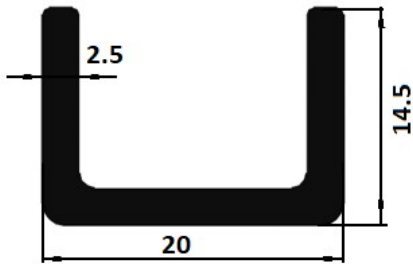

SL.NO.	SECTION NO.	WEIGHT(KG/M)
1	5211	0.294

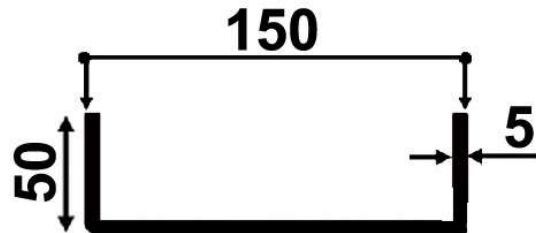

SL.NO.	SECTION NO.	WEIGHT(KG/M)
1	5214	3.210

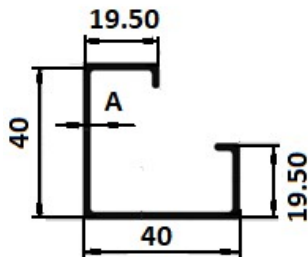

SL.NO.	SECTION NO.	A	WEIGHT(KG/)
1	5215	1.91	0.628
2	5216	2.30	0.738

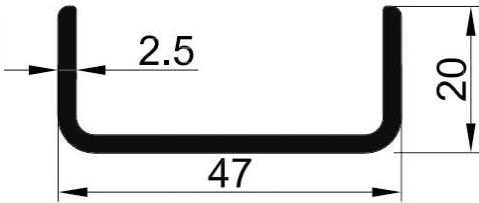

SL.NO.	SECTION NO.	WEIGHT(KG/M)
1	5219	0.528

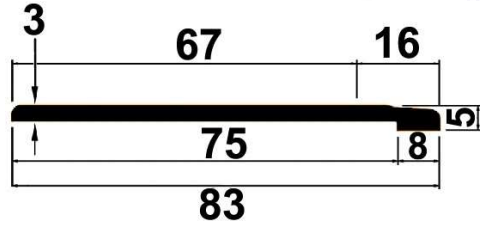

SL.NO.	SECTION NO.	WEIGHT(KG/M)
1	5220	0.689

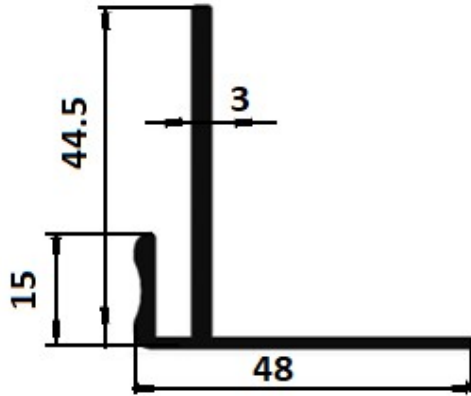

SL.NO.	SECTION NO.	WEIGHT(KG/M)
1	5221	0.632

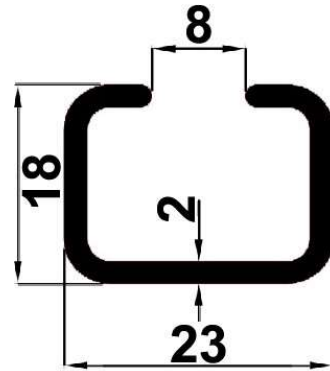

SL.NO.	SECTION NO.	WEIGHT(KG/M)
1	5222	0.326

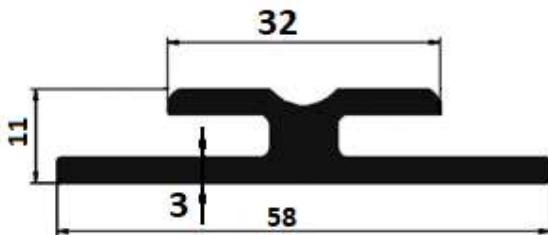

SL.NO.	SECTION NO.	WEIGHT(KG/M)
1	5223	0.803

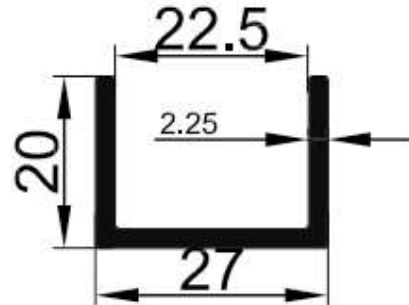

SL.NO.	SECTION NO.	WEIGHT(KG/M)
1	5212	0.380

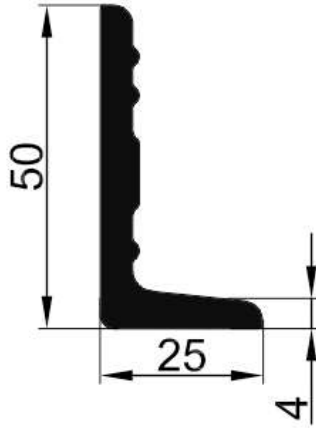

SL.NO.	SECTION NO.	WEIGHT(KG/M)
1	5235	0.987

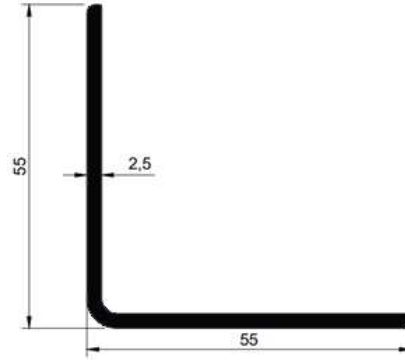

SL.NO.	SECTION NO.	WEIGHT(KG/M)
1	5048	0.712

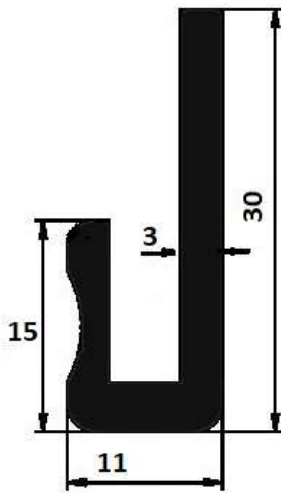

SL.NO.	SECTION NO.	WEIGHT(KG/M)
1	5225	0.382

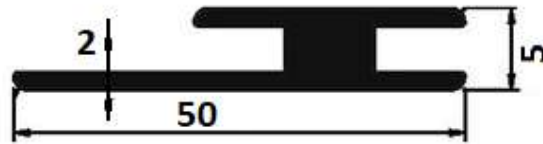

SL.NO.	SECTION NO.	WEIGHT(KG/M)
1	5226	0.561

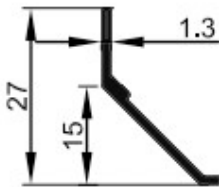

SL.NO.	SECTION NO.	WEIGHT(KG/M)
1	5230	0.132

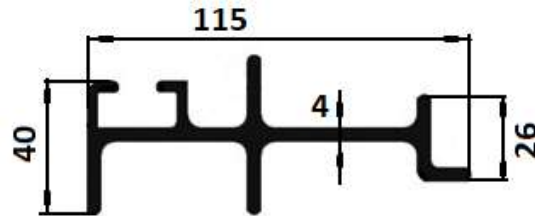

SL.NO.	SECTION NO.	WEIGHT(KG/M)
1	5228	2.781

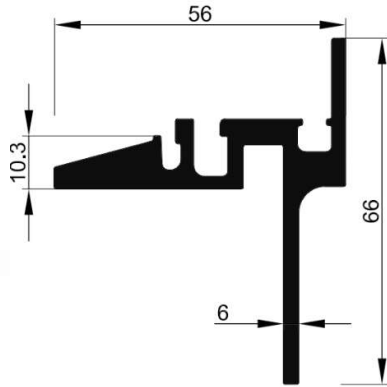

SL.NO.	SECTION NO.	WEIGHT(KG/M)
1	5232	1.567

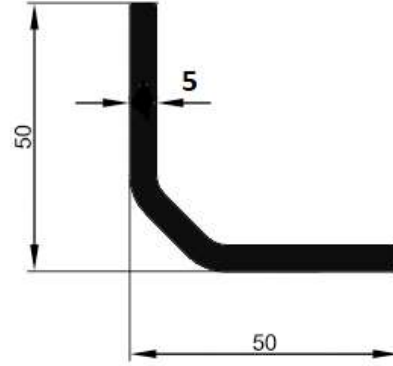

SL.NO.	SECTION NO.	WEIGHT(KG/M)
1	5236	1.175

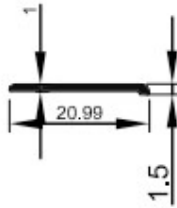

SL.NO.	SECTION NO.	WEIGHT(KG/M)
1	5234	0.058

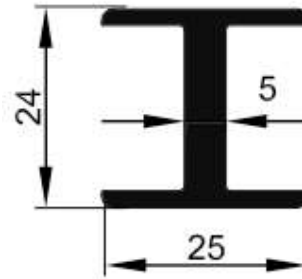

SL.NO.	SECTION NO.	WEIGHT(KG/M)
1	5240	0.535

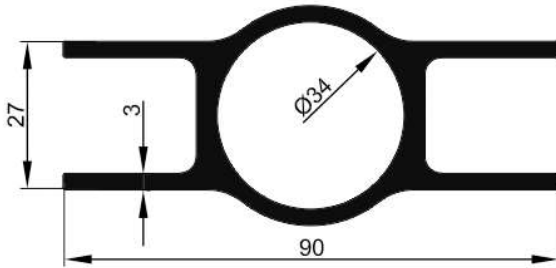

SL.NO.	SECTION NO.	WEIGHT(KG/M)
1	5238	2.114

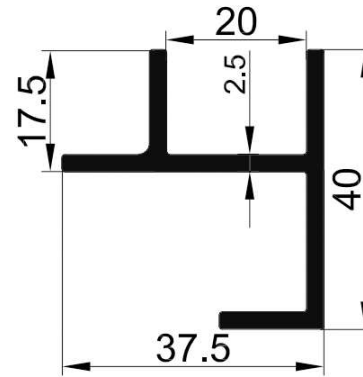

SL.NO.	SECTION NO.	WEIGHT(KG/M)
1	5242	0.693

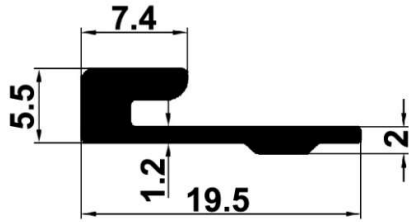

SL.NO.	SECTION NO.	WEIGHT(KG/M)
1	9706	0.135

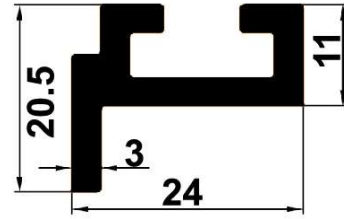

SL.NO.	SECTION NO.	WEIGHT(KG/M)
1	9705	0.477

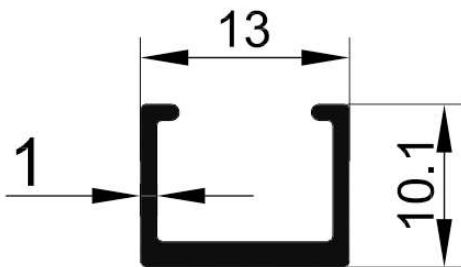

SL.NO.	SECTION NO.	WEIGHT(KG/M)
1	5270	0.110

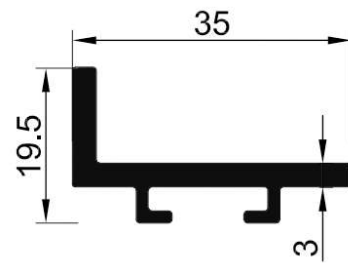

SL.NO.	SECTION NO.	WEIGHT(KG/M)
1	5547	0.440

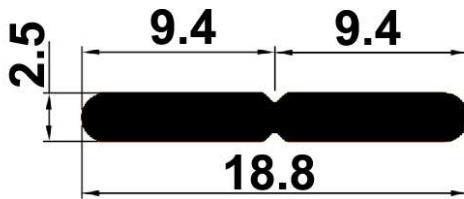

SL.NO.	SECTION NO.	WEIGHT(KG/M)
1	5515	0.121

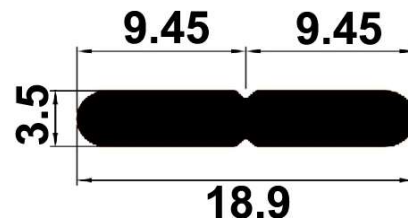

SL.NO.	SECTION NO.	WEIGHT(KG/M)
1	5517	0.560

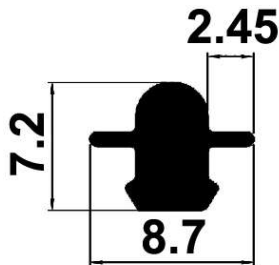

SL.NO.	SECTION NO.	WEIGHT(KG/M)
1	5530	0.083

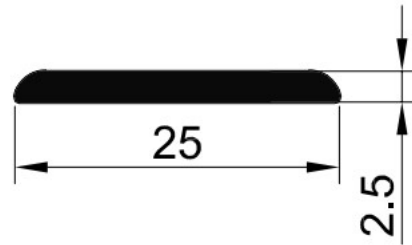
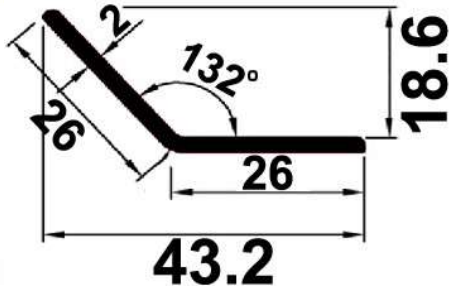

SL.NO.	SECTION NO.	WEIGHT(KG/M)
1	5008	0.273

SL.NO.	SECTION NO.	WEIGHT(KG/M)
1	7235	0.161

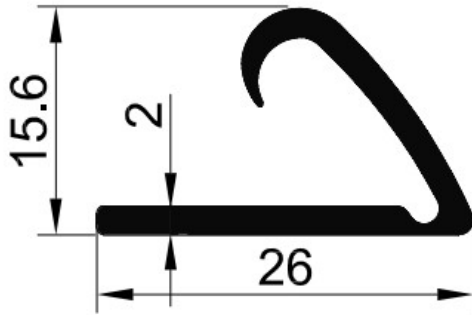

SL.NO.	SECTION NO.	WEIGHT(KG/M)
1	5243	0.247